

Single-stage Thermoelectric Cooler (N=18)
1MDD025-018-027/Z3/PA

ΔT_{max} K	Q_{max} W	I_{max} A	U_{max} V	ACR Ohm	H mm
73	1.62	1.29	2.24	1.44	0.7

Performance data is specified at 300K, Vacuum

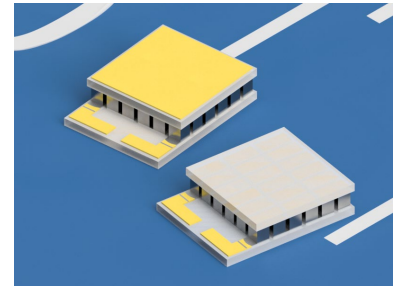

Dimensions

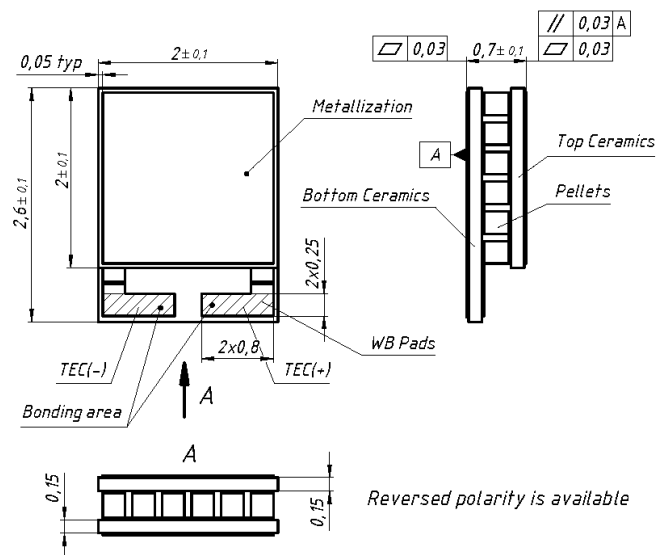

Manufacturing Options

A. TEC Assembly Solder

1. Lead-free Solder Sn-Sb (Tmelt = 230°C) - default
2. Lead-free Solder Au-Sn (Tmelt = 280°C) - available by request

B. TEC Ceramics

1. AlN 100% - default
2. Al₂O₃ 100%
3. Mixed solution (AlN/Al₂O₃)

C. Ceramics Surface Options

1. Blank ceramics
2. Metallized (Au plating)
3. Metallized and pre-tinned

D. Thermistor (optional)

Can be mounted on the edge of TEC cold side.
Calibration is available by request.
Various thermistor solutions are available

E. TEC Terminal Contacts

1. WB pads
2. WB posts

Performance Data

1MDD025-018-027/Z3/PA

@27°C	ΔT_{max} K	Q_{max} W	I_{max} A	U_{max} V
Vacuum	73	1.62	1.29	2.24

@50°C	ΔT_{max} K	Q_{max} W	I_{max} A	U_{max} V
Dry N2	82	1.78	1.26	2.49

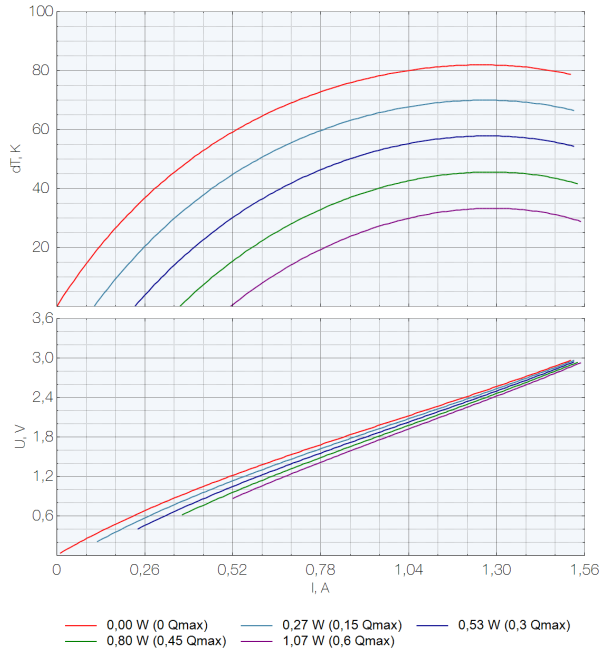
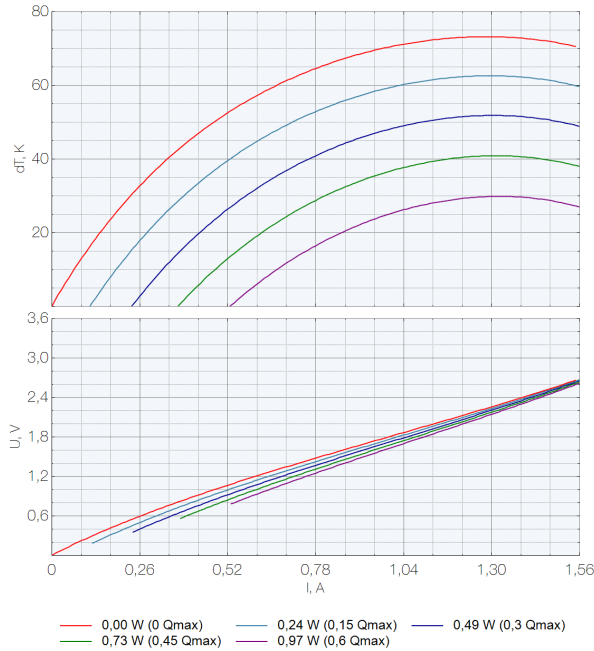

@75°C	ΔT_{max} K	Q_{max} W	I_{max} A	U_{max} V
Dry N2	90	1.87	1.21	2.73

@85°C	ΔT_{max} K	Q_{max} W	I_{max} A	U_{max} V
Dry N2	93	1.86	1.19	2.83

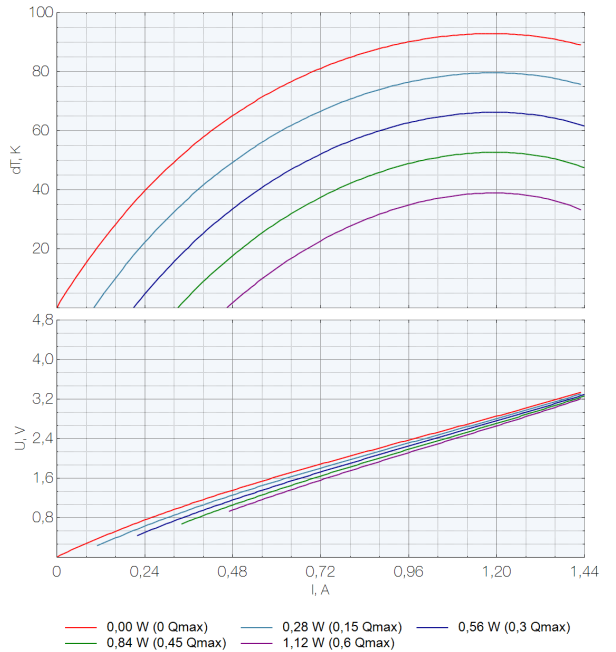
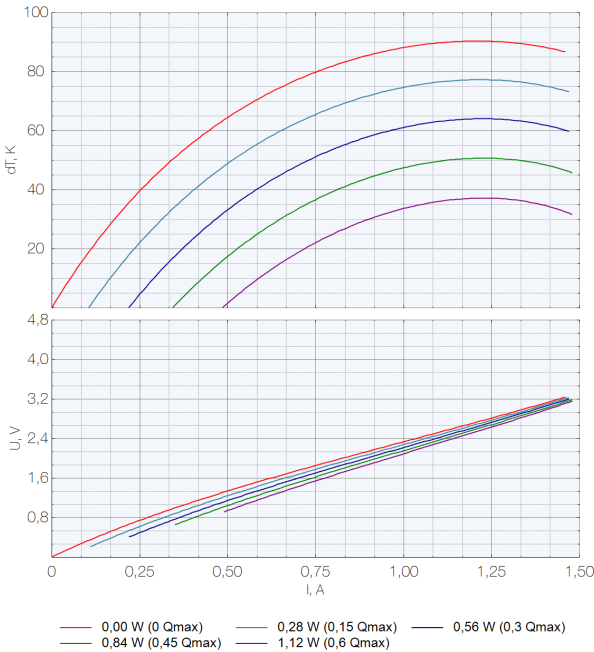

Note: TEC performance data is specified at optimal conditions, $T_{hot}=T_{amb}$. Please, use TECCad Software for estimations under different conditions, or contact RMT or its branches directly.

Thermoelectric Cooler Overview

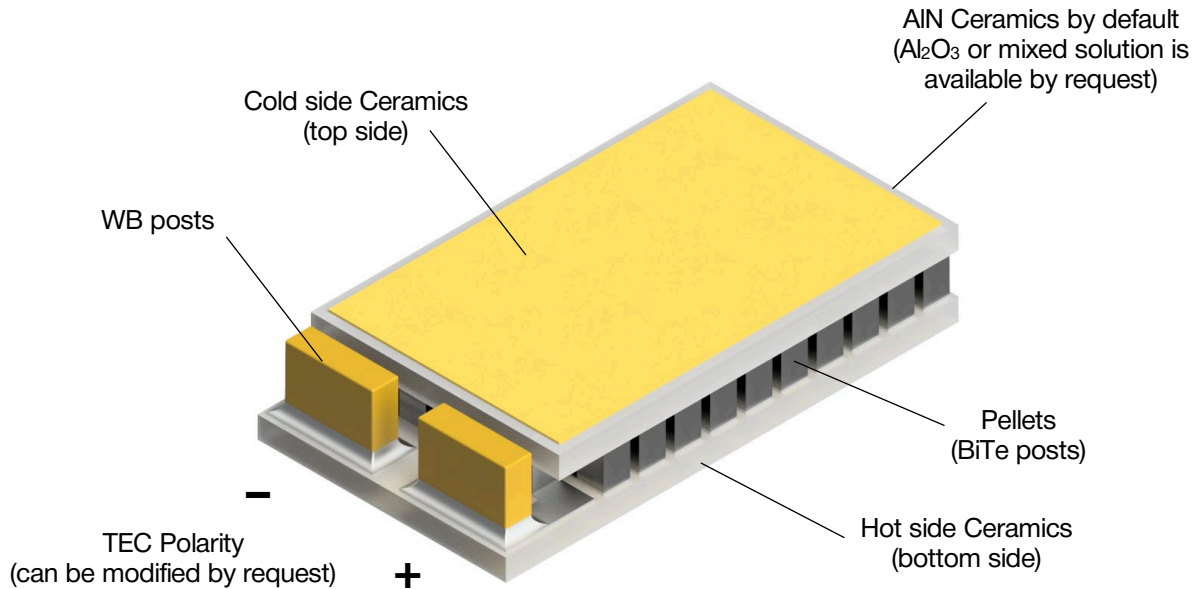

Application Tips

1. Never heat TE module more than 200°C (TEC assembled at 230°C).
2. Never heat TE module more than 260°C (TEC assembled at 280°C).
3. Never use TE module without an attached heat sink at hot (bottom) side.
4. Do not apply DC current higher than I_{max} .
5. Never use TE module without an attached heat sink at hot (bottom) side.

Installation

1. Soldering. This method is suitable for a TE module with metallized outside surfaces. RMT provides this option and also makes pre-tinning for TE modules.
2. Gluing. It is an up-to-date method that is used by many customers due to availability of glues with good thermoconductive properties. A glue is usually based on some epoxy compound filled with some thermoconductive material such as graphite or diamond powders, silver, SiN and others. The application of a specific type depends on application features and the type of a TE module.

Additional Options

TEC Polarity

TEC Polarity can be modified by request. The specified polarity in this datasheet is typical. It can be reversed in accordance to Customer application requirements.

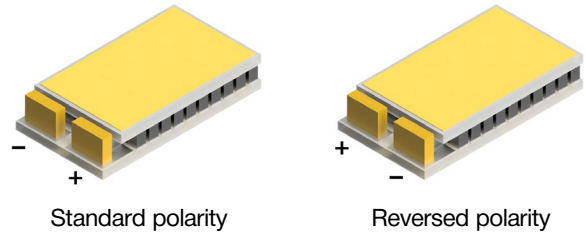

Parylene coating

Parylene layer is crucial for cases where condensation from a gaseous media could occur. It increases reliability and protects parts of thermoelectric cooler from exposure to non-hermetic environment.

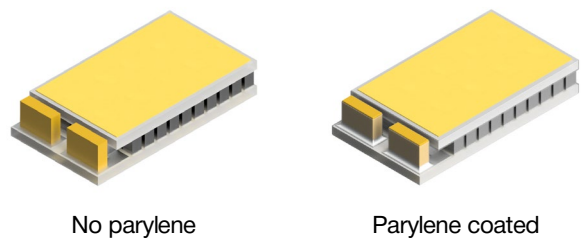

Optimization for WB process

The solution with WB pads (no posts) is provided by default. WB posts are available by request. The dimensions of WB posts can be modified and optimized for Customers application. WB posts are made of Copper, Au plated.

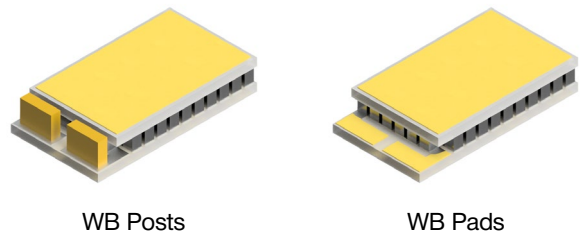

Customized Au Patterns

Customized Au patterns on thermoelectric cooler cold side are available by request. Selective Pre-tinning over pattern is also available. Please, contact RMT for additional information about customized Au patterns requirements.

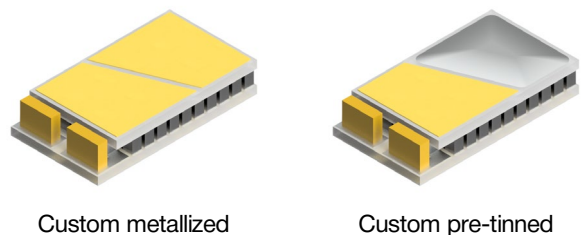

TEC Height modification

Standard TEC height can be modified without performance changes by using ceramics of different thickness. Standard thermoelectric cooler height (specified in this datasheet) can be increased or decreased by request.

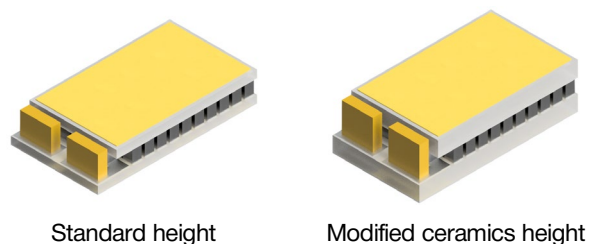

Important Notes

1. TEC Performance in this datasheet is specified in typical ambient condition modes (Vacuum, +27°C; Dry N2, +50°C; Dry N2, +75°C; and Dry N2, +85°C). The performance may differ under other conditions. Please, use RMT TECCad software for detailed analysis, or contact RMT specialists for additional TEC performance info.
2. TEC ACR and U_{max} values are sensitive to ambient temperature. These values can be different from those specified in the datasheet at other ambient conditions. ACR and U_{max} raise with ambient temperature increasing.
3. TEC dT_{max} is specified at zero heatload, while Q_{max} is specified at zero dT (check Fig.1 for example). TEC dT_{max} and Q_{max} values raise with ambient temperature (check Fig. 2 for example). Please, use RMT TECCad for additional info, or contact RMT specialists directly.
4. Thermoelectric coolers have the best performance in the temperature range from near room up to +80..90°C. TEC cooling performance is less at ambient temperatures below 0°C. TECs are not suitable to operate at cryogenic temperatures.
5. Driving a TEC at I_{max} or U_{max} doesn't mean max performance mode. The real optimal mode may depend on operating conditions, required dT level and application heatload. In fact, a better performance can be reached at operating current and voltage lower than I_{max} and U_{max} values specified in datasheet.
6. It is strongly recommended to avoid a direct mounting of thermoelectric cooler to pure Copper, Aluminium or Nickel materials as well as a mounting of objects from these materials on TEC cold side. Any material with high CTE (Coefficient of Thermal Expansion) may affect on TEC lifetime and even damage TEC in case of improper mounting, thermal shock and/or temperature cycling. In case of above-mentioned materials necessity, it is recommended to use elastic "soft" solders or glues with large modulus of elasticity (Indium-based solders or silicon-based thermoconductive glues).
7. RMT confirms that all RMT thermoelectric coolers are qualified and meet the requirements of Telcordia GR-468 Standard. The up-to-date Reliability Report is available by request. RMT warranties thermoelectric coolers lifetime no less than 250K-300K operating hours under normal application conditions.

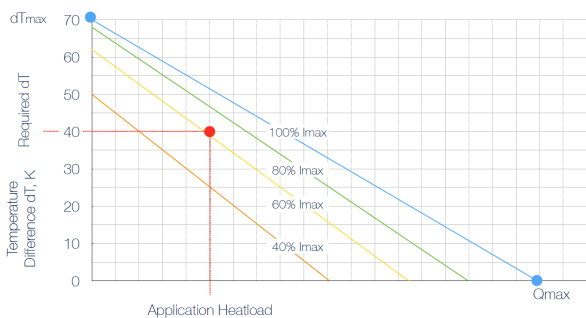
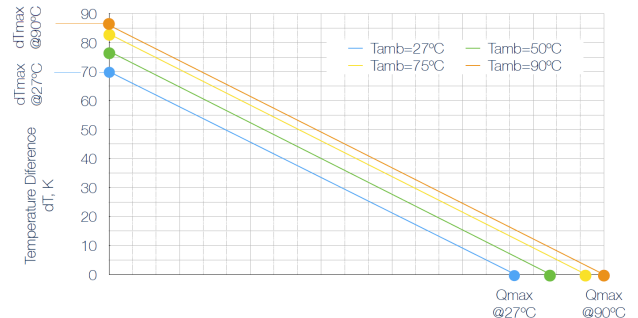
 Fig. 1 - Understanding dT_{max} and Q_{max}

 Fig. 2 - Single-stage TEC dT_{max} and Q_{max} example

Contacts

HEAD OFFICE

46 Warshavskoe shosse. Moscow 115230 Russia

Tel: +7-499-678-20-82

E-mail: info@rmtltd.ru

CHINA

翰銓科技香港有限公司

Hantech Technology

RM566,5/F, Hanjing Mansion, Nanshan District, Shenzhen, China

Tel: +86-0755-86215941

E-mail: bob.han@htthk.com

Web site: <http://www.htthk.com>

廈門博晶光電技術有限公司

XIAMEN ZIBO OPTOELECTRONIC CO. LTD.

Room 120, Chuanye Building, Chuanye Park,

Xiamen Torch Hi-Tech Industrial Development Zone

Xiamen, China , 361006

Tel: +86-1360-6026187

E-mail: wenty.liu@ziboee.com (Wenty Liu)

KOREA

Sunflower Energy

3F, 16, Deokseongsandan 2-ro 50beon-gil, Idong-eup, Cheoin-gu, Yongin-si,

17130, Korea

Tel: +82 31-2767992

E-mail: jay_sunfl@naver.com

Web site: <http://www.sunfl.co.kr>

Legal Notice

All logos, images, trademarks and product names (collectively Materials) are proprietary to RMT and/ or any of its affiliates, or subsidiaries, or other respective owners that have granted RMT the permission and/or license to use such Materials. All images are provided by RMT and are subjects of copyright protection.

RMT, Hantech Technology, XIAMEN ZIBO OPTOELECTRONIC CO. LTD. and Sunflower Energy do not grant a copyright license (express or implied) to the Recipient, except that Recipient may reproduce the logos, images and text materials in this press-release without any alteration for non-promotional or editorial purposes only with a written note about materials owner.

Copyright Protection Warning

Graphic materials and text from this datasheet may not be used commercially without a prior response in writing on company letterhead and signed by RMT authority.

Thank you for respecting the intellectual property rights protected by the International Copyright laws. All Images contain RMT hidden watermark for the immediate proof of their origin.



RMT Image

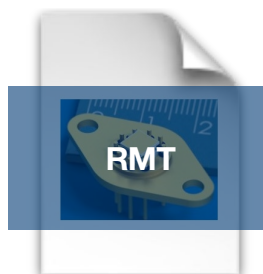

Hidden Watermark